

# Model TPX4190 USER MANUAL



Via Enrico Fermi, 57/59 - 10091 ALPIGNANO (TO)  
☎ Telefono: +39 (0)11 9664616 Fax: +39 (0)11 9664610  
E-mail: [srlmect@mect.it](mailto:srlmect@mect.it) - C.F. e P.I. 04056380019

ME7109\_03  
05/25

**INDEX**

1 Introduction..... 1

    1.1 Staff qualification..... 1

    1.2 Symbols..... 1

    1.3 Nomenclature ..... 2

    1.4 Safety ..... 2

    1.5 CHARACTERISTICS ..... 3

2 Mechanics ..... 4

    2.1 Drilling template ..... 4

    2.2 Depth..... 4

3 TPX4190 Wiring ..... 5

    3.1 Power supply..... 5

    3.2 Digital inputs..... 6

    3.3 Digital outputs..... 6

    3.4 RS485 Serials..... 7

    3.5 Terminal block tip size M2..... 7

    3.6 Isolations ..... 7

    3.7 Fuses..... 7

    3.8 Peripherals..... 8

        3.8.1 USB ..... 8

        3.8.2 Ethernet ..... 8

## 1 Introduction

To ensure quick installation and commissioning of the devices described, we recommend that you carefully follow the information provided in this manual.

### 1.1 Staff qualification

The products described in this manual are to be used exclusively by personnel with experience in PLC programming, or technicians specialized in the use of electrical devices oriented to automation. MECT Srl declines all responsibility for malfunctions and damages caused by improper use of MECT devices, due to failure to comply with the information contained in this manual. MECT Srl has a technical assistance laboratory.

### 1.2 Symbols

**Danger**

Please follow this information to protect people from harm.

**Warning**

Please follow this information to protect your device.

**Attention**

Conditions that must be observed for a more effective installation

**ESD (Electrostatic Discharge)**

Warning: Possibility of damage to components due to electrostatic discharges

**Note**

Steps to follow for a correct installation

**Additional Information**

### 1.3 Nomenclature

Operator panel: TPX4190

PLC: TPX4190

HMI: Human Machine Interface

### 1.4 Safety



#### **Attention**

Turn off devices before working on terminals

**ESD** (Electrostatic Discharge)



The modules are equipped with electronic components that can be damaged by electrostatic discharge. Whenever you handle the modules, make sure that the environment is well grounded.

The instrument does not have an ON-OFF switch and an internal fuse, but it switches on immediately after supplying the correct supply voltage (check the supply voltage value indicated on the instrument label under the heading “Power”). Provide a power supply line that is as direct as possible and separate from the line that supplies the power elements.

For safety reasons, it is necessary to provide a two-phase disconnect switch with fuse located near the appliance and easily accessible by the operator.

Avoid having power elements (contactors, motors, drives, etc. ), excessive humidity, heat sources and corrosive gases in the same panel.

The instruments must be powered by safety transformers or SELV type power supplies.

**1.5 CHARACTERISTICS**

Broadcom BCM2711 SoC with a 1.5 GHz 64-bit quad- core ARM Cortex-A72 microprocessor system .

Table 1

<b>PLC Hardware Features</b>	
PLC Processor	Broadcom BCM2711 SoC with a 1.5 GHz 64-bit quad-core ARM Cortex-A72
RAM	2GB
eMMC	8GB
Real Time Clock	Present with rechargeable buffer battery
Screen	TFT 1920 x 1080 pixels 16M colors
Touch screen	Capacitive
Ethernet 0	1Gb/s in auto-recognition
Ethernet 1	10Mbit/s - 100Mbit/s in self-recognition
USB 1	Host 2.0
USB 2	Host 2.0
RS485 – SERIAL PORT 0	2-wire serial
RS485 – SERIAL PORT 3	2-wire serial
Micro SD	NA
Case	Metallic
Protection level	IP65
<b>PLC Software Features</b>	
Operating system	Raspbian OS 64bit
Graphics	Based on QT4.8.7 libraries
ModBus fieldbus	Modbus RTU and Modbus TCP
Mass storage	Possibility to save historical data
<b>Fieldbus Features</b>	
Modbus-RTU	2-wire Master/Slave
ModbusTCP	Server/Client
<b>Supply voltage</b>	
12 ÷ 36VDC	
Power absorbed	12W digital outputs excluded

**Electromagnetic compatibility**

Reference standard: IEC61131-2:2017

Precautions: USB cable < 1m; Digital I/O < 3m; LAN and serial < 30m.

## 2 Mechanics

Metal case.

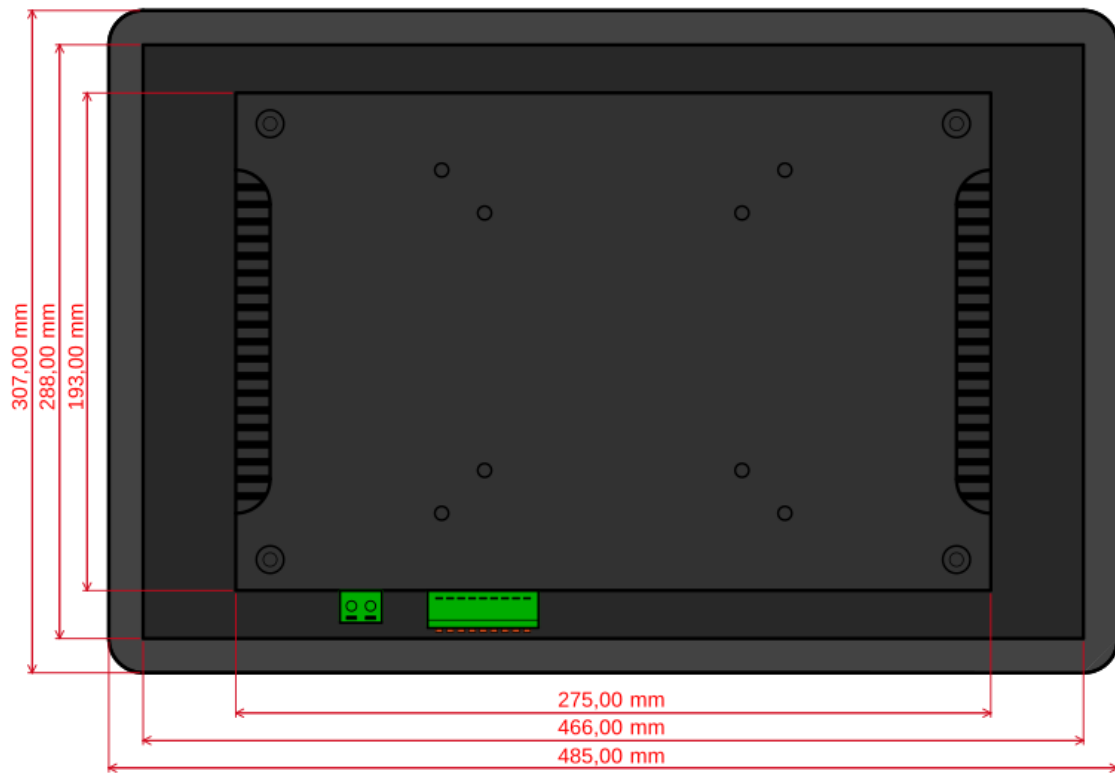

### 2.1 Drilling template



### 2.2 Depth



### 3 TPX4190 Wiring

The following figure shows the layout of the connectors on the panel.

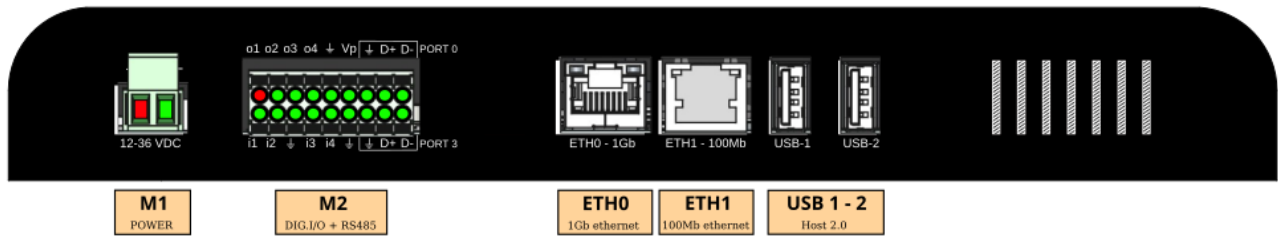

Table 2

ID	TPX4190	
M1	Panel power supply	24Vdc 600mA
M2		1 DOUT 1 2 DOUT 2 3 DOUT 3 4 DOUT 4 5 GND 6 VPOT 7 GND 8 D0 + (UART3) MS SERIAL PORT 0 9 D0 – (UART3) M.S. SERIAL PORT 0 10 DIN 1 11 DIN 2 12 GND 13 DIN 3 14 DIN 4 15 GND 16 GND 17 D1+ (UART4) M.S. SERIAL PORT 3 18 D1- (UART4) M.S. SERIAL PORT 3
ETH0	Ethernet 1Gb (IP default in DHCP) for remote connection (sMily)	Bit rate max: 1Gbit/sec
ETH1	Ethernet 100Mb (IP default:192.168.5.211)	Bit rate max: 100Mbit/sec
USB 1	USB A 1	Host 2.0
USB 2	USB A 2	Host 2.0

#### 3.1 Power supply

If the panel is powered at the nominal voltage of 24Vdc, a power supply that can supply at least 2A is required.

**3.2 Digital inputs**

The TPX4190 has 4 PNP digital inputs available. The connection is shown in the following figure.

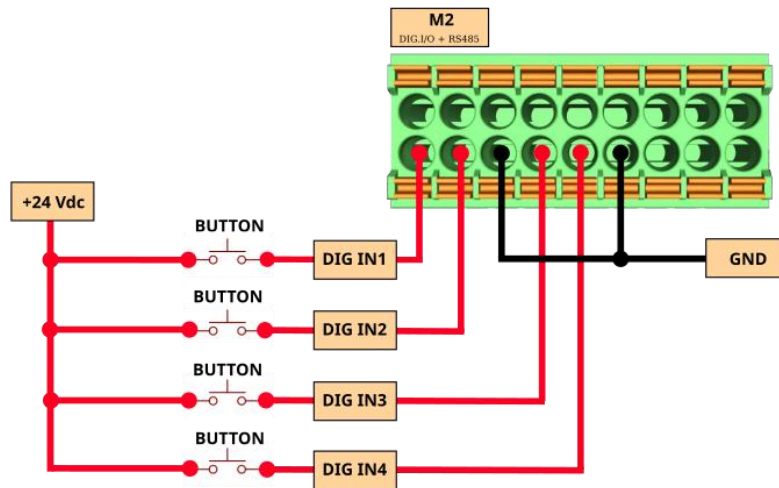

**3.3 Digital outputs**

The TPX4190 has 4 PNP digital outputs available. The connection is shown in the following figure.

Note: The power supply for the digital outputs must be brought to terminal 6.

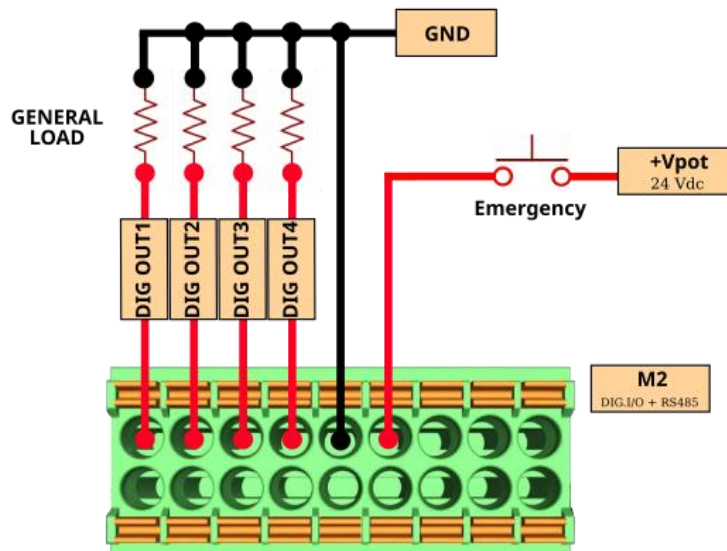

**3.4 RS485 Serials**

The TPX4190 has 2 RS485 channels available. The connection is shown in the following figure.

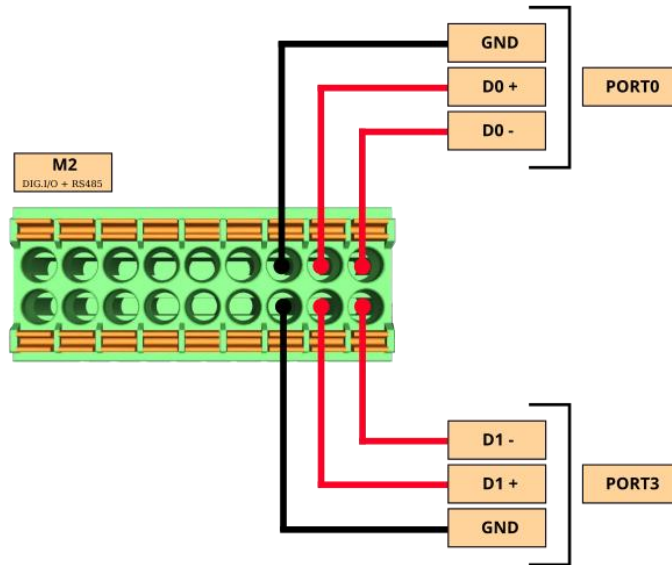

**3.5 Terminal block tip size M2**

For wiring on terminal block M2, which contains digital inputs and outputs as well as RS485, we recommend using the following socket terminals:

1. conductor diameter 0.34mm<sup>2</sup> and terminal length 10mm
2. conductor diameter 0.5mm<sup>2</sup> and terminal length 10mm
3. conductor diameter 1mm<sup>2</sup> and terminal length 10mm

**3.6 Isolations**

The device does not provide galvanic isolation zones between inputs, outputs and power supply.

**3.7 Fuses**

The system does not provide internal fuses, however, to protect the input stage of the TPX4190 operator panel/ PLC power supply , it is recommended to insert a 2A fuse.



**Attention**

Using an incorrect power supply voltage may cause irreversible damage to the devices.

**3.8 Peripherals****3.8.1 USB**

The TPX4190 features two USB 2.0 host ports , which can be used for:

- Save process data
- Connect peripherals with USB interface such as printers, mice, keyboards, barcode scanners, etc.
- Software Updates

**3.8.2 Ethernet**

The TPX4190 operator panel/ PLC is equipped with two Ethernet ports, one 10/100Mbit/s in autonegotiation ( default static IP address 192.168.5.211), the other 1Gbit/s ( default IP address in DHCP), furthermore the connection cable between the TPX4190 and a personal computer can be either direct or crossed.